

GYPROC FACADE SYSTEM

Our full through-the-wall solution for
non-loadbearing steel framing system infill



We offer a portfolio of wraparound systems for non-loadbearing light gauge steel infill solutions to support you in this fast-moving and often complex industry.

Our solutions are tested to meet 60, 90 and 120-minute fire resistance in both directions on Gyproc Facade Stud framework infill systems, and we'll work with you to meet your thermal performance requirements. Our systems have been developed and tested with the same rigour and attention to detail that we apply to all our products and systems.



CONTENTS

2 Introduction

SYSTEMS

6 120mins Fire Resistance

7 T106015 (EN)

8 T106022 (EN)

9 T106023 (EN)

10 T106030 (EN)

11 T106036 (EN)

12 90mins Fire Resistance

13 T106019 (EN)

14 T106021 (EN)

15 T106033 (EN)

16 T106034 (EN)

17 T106035 (EN)

18 60mins Fire Resistance

19 T106017 (EN)

20 T106018 (EN)

21 T106031 (EN)

22 T106032 (EN)

24 Construction Details

30 Bespoke Solutions

32 Sustainability

33 Plasterboard Recycling Services

34 Environmental Product Declarations

35 The BREEAM® Certification

36 LEED® Certification

External Wall Construction

Introduction

Gyproc Facade System brings together Gyproc and Isover products to deliver tested fire and acoustic performances and a range of options for thermal performances on Gypframe non-loadbearing infill systems.

This system has been developed and tested with the same rigour and attention to detail that we apply to all our other products and systems. Gyproc and Isover products are wrapped around the Gyproc stud framework, offering substantiated performances backed up by test evidence and technical know-how.

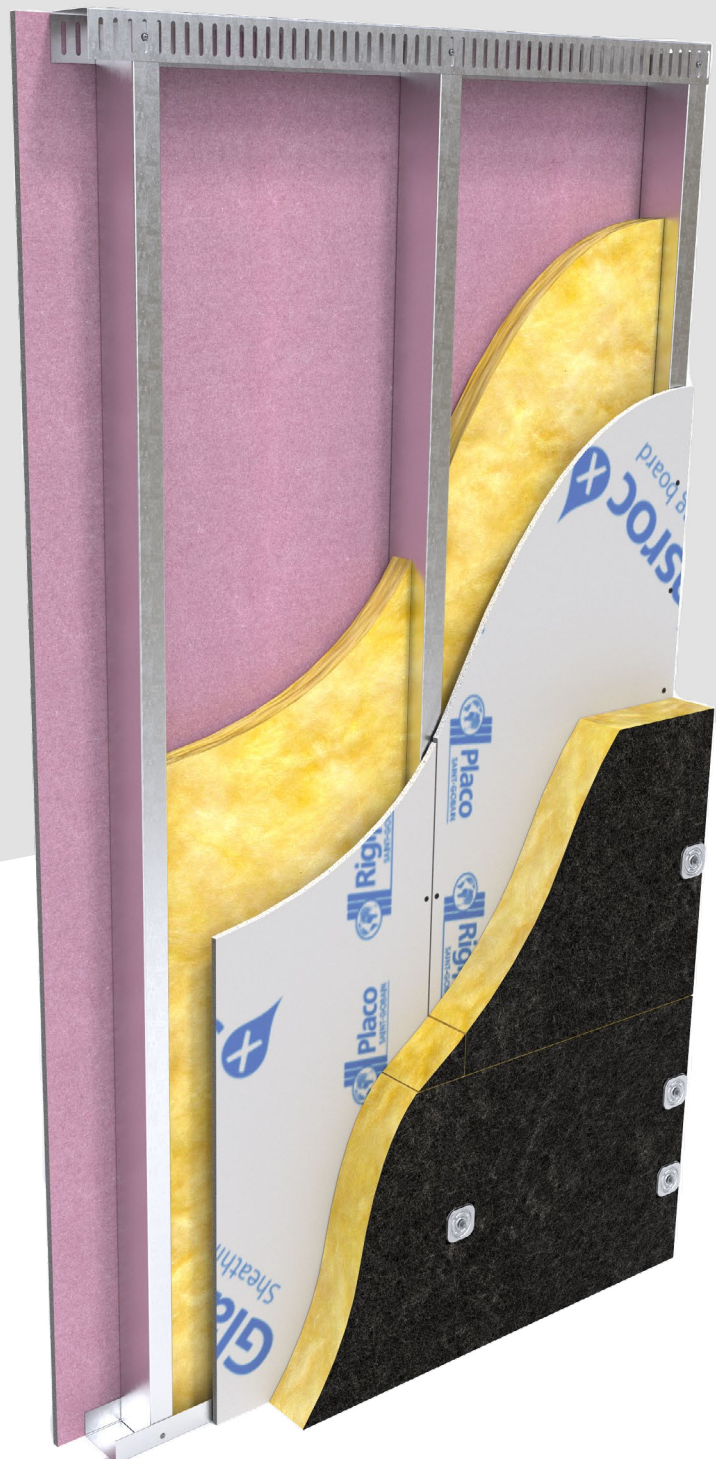

Infill walls

The panels for infill walls are generally constructed from individual elements, which are cut to length and installed on site. The panels fit between the elements of the primary structural frame. The panels consist of a bottom track attached to the floor and a head track attached to the underside of the floor above. Vertical light steel C sections are fitted between the head and base tracks, typically at 600mm centres (or reduced to 400 or 300mm where structural design requires closer spacing). In some cases, the panels may be constructed such that they project past the edge of the primary structure.

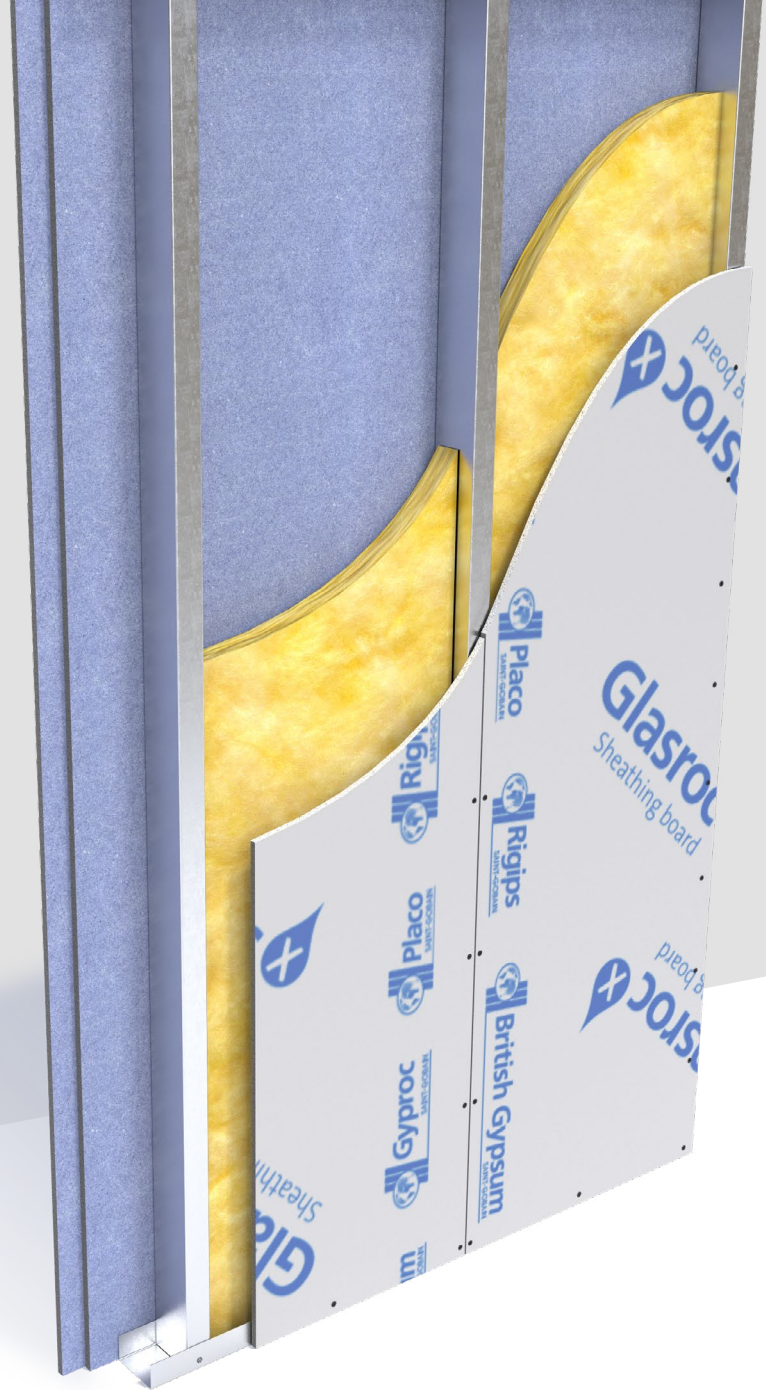

Key facts

- Systems designed to offer flexible specification options
- Meet and exceed thermal performance needs through a range of insulation solutions
- Comprehensive fire and acoustic tested solutions
- Fire resistance to BS-EN 1364-1 EI 60, 90 and 120 mins (inside to out, outside to in)
- Up to Rw 56 dB tested sound insulation performance
- Installation details for junctions, abutments, windows and deflection requirements

Saint-Gobain Ireland - Our approach

- Our approach brings together best-in-class Gyproc and Isover products delivering tested fire, acoustic and thermal performances on Gypframe non-loadbearing infill systems. This is backed with technical specifications, guidance and advice on specific issues including junctions, abutments and deflection heads – just as we do with all our other products and systems.
- Gyproc Facade System is a system that works in conjunction with Gyproc Facade Stud framework to provide a required through-wall performance. We describe these as wraparound solutions for light gauge steel infill systems, as our products are ‘wrapped around’.



Responsibilities

Performance requirements of the building are the responsibility of the design team in conjunction with the contractor. Design teams will need to satisfy themselves that use of any product meets all relevant national Building Regulations and guidance as well as local, national, and other applicable standards relevant for their construction or application, including requirements in relation to fire and applicable height restrictions.

Structural design

Gyproc and Isover Ireland, by way of our in-house design service, will work alongside design teams in the specification of a wraparound solution that will meet the specific project requirements. We would support a project with technical specifications, details and installation guidance on our products.

Fire design

Our wraparound solutions for non-loadbearing steel infill systems, comprise a series of components when tested together, and specified and installed as tested, can provide evidence of fire performance. There should be no substitution of components without our written approval.

Direction of test

External wall systems are asymmetrical and therefore the building designer should check that the fire test evidence is compliant for the project requirements, for example; fire exposure is tested from each side separately.

Cavity barriers and fire breaks

Cavity barriers and fire breaks must be installed in accordance with the requirements of the relevant Building Regulations. The nature of these cavity barriers and fire breaks will vary according to the design requirements of each particular project and are the responsibility of the architect in conjunction with the contractor.

Fire protection of structural steel

We can provide details to fully encase all structural steel. It may be possible through third-party test data (by a suitably qualified structural or fire engineer) to determine whether the conditions offered by the lining are sufficient to protect hot rolled elements, without the need for additional fire protection measures.

Reaction to fire

The external walls of the building shall adequately resist the spread of fire over the walls and from one building to another, having regard to the height, use and position of the building. Materials which become part of an external wall, or specified attachment, of a relevant building should be of European Classification A2-s1, d0 or A1, classified in accordance with BS EN 13501-1:2007. Board linings, framing and insulation materials in Gyproc Facade System are either non-combustible (Euroclass A1) or of limited combustibility (Euroclass A2-s1-d), classified in accordance with BS EN 13501-1:2007.

Membranes, seals (for example; EPDM rubber), gaskets, fixings and sealants (for example; Glasroc X Sealant) are exempt from this requirement.

Cladding

Tests pertaining to cladding are entirely separate with separate test standards as outlined within Approved Document guidance

Thermal design

The thermal performance of a building is a critical part of its performance with ever increasing scrutiny and tighter targets being given to the building's energy efficiency. Improving the energy efficiency of the building will not only help save energy but will ensure that obligations towards reducing the impact of carbon emissions can be achieved. By incorporating thermal insulation into the envelope of the building both the thermal comfort of the occupants and the performance of the building can be improved. It is also possible to take this one step further and by exceeding current requirements ensure that the building will also start to meet future targets.

U-values

To meet the thermal requirements of the Building Regulations, it will be necessary to provide U-value calculations on the thermal performance of the system in accordance with BR 443 (2019).

The facade type and its fixing detail will determine the calculation method needed for demonstration of thermal performance.

We can provide advice upon which type of calculation you will require and if you contact us directly, we can work with you to find the correct specification for your project. Contact us through Technical Support at Gyproc.ie

Airtightness and moisture management

Dependent on factors, such as location and building type, there are specific air permeability requirements that may apply to your project. The air permeability test gives a measure of the amount of air that leaks through the building envelope and, as such, is one of the key sources of heat loss from a building.

While our products and systems have been used in situations where a target air permeability rate has been met, this does not cover all possible applications. Gyproc Facade System has not been designed or tested as an air barrier and as such, we strongly recommend that guidance is sought from an air tightness specialist, who will be best placed to advise you on whether additional air seals or construction methods will be required. There are a number of factors that should be considered when determining if a breather membrane is required, including finished façade type, building location, and required air tightness performance and the design team should satisfy themselves as to the requirement of a breather membrane.

Acoustic design

Sound Insulation

Considerations against noise should be taken at the design stage and during construction of the building. The correct acoustic climate must be provided in each space, and noise transmission levels should be compatible with the building's usage, and external environment.

Installation

The plasterboard linings to both sides of the framework should be installed to ensure that there are no coincident joints.

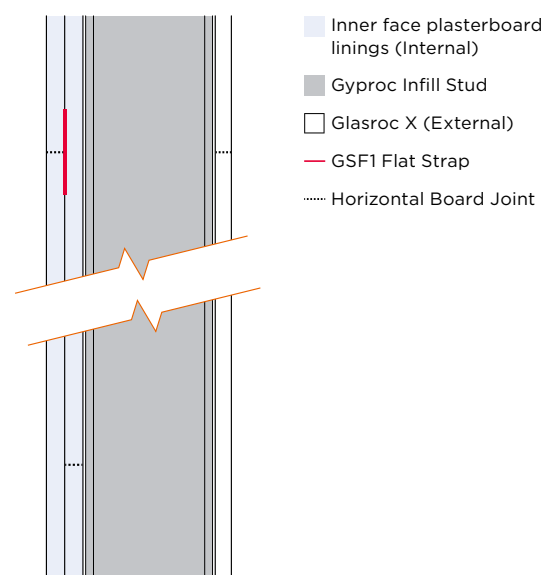



SYSTEMS

**120mins Fire
Resistance**

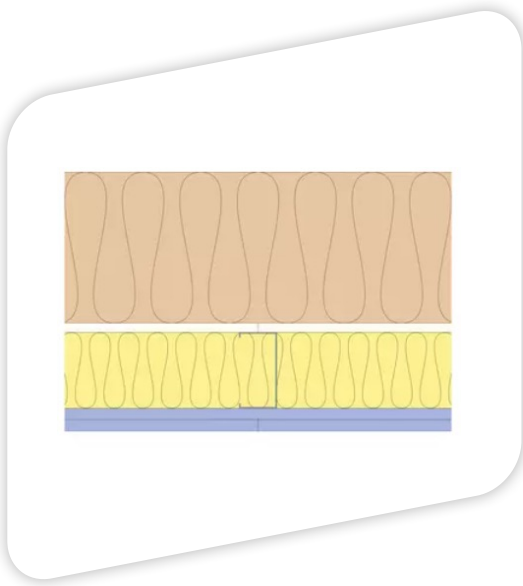

Gyproc Facade System T106015 (EN)

A non-loadbearing external wall construction including a 20mm deflection head with an inner layer of Glasroc X Sheathing Board 12.5mm and outer layer of 200mm Isover Polterm Max Plus Insulation to external side and two layers of Gyproc SoundBloc 15mm to the internal side of 100mm Gypframe metal stud framework. 100mm Isover Acoustic Insulation in the cavity. For heights up to 3000mm.

| | | | | | |
|-----------------|-----|-----------------------|-----|---------------------|------|
| Fire Insulation | 120 | Fire Integrity (mins) | 120 | Maximum Height (mm) | 3000 |
|-----------------|-----|-----------------------|-----|---------------------|------|

List of products

| | |
|-------------------------------|--|
| External insulation | Layer 1: 200mm Isover Polterm Max Plus |
| Board side 2 | Layer 1: Glasroc X Sheathing Board 12.5mm |
| Stud | 100mm Gyproc Facade Stud |
| Head channel | 104mm Gyproc Facade Slotted Head Track |
| Base channel | 104mm Gyproc Facade Base Track |
| Stud fixing | 5.5mm × 25mm course thread TEK screw |
| Abutments and openings | 100mm Gyproc Facade Stud |
| Insulation | Layer 1: 100mm Isover Acoustic Insulation |
| Board side 1 | Layer 1: Gyproc SoundBloc 15mm Layer 2: Gyproc SoundBloc 15mm |
| Screws side 1 | Layer 1: Gyproc Jack-Point Screws 25mm Layer 2: Gyproc Jack-Point Screws 41mm |
| Screws side 2 | Layer 1: Glasroc X Screws 25mm |
| External board joints | Glasroc X Sealant |
| Sealant | Gyproc Sealant |
| Fixing strap | Gypframe GFS1 Fixing Strap |

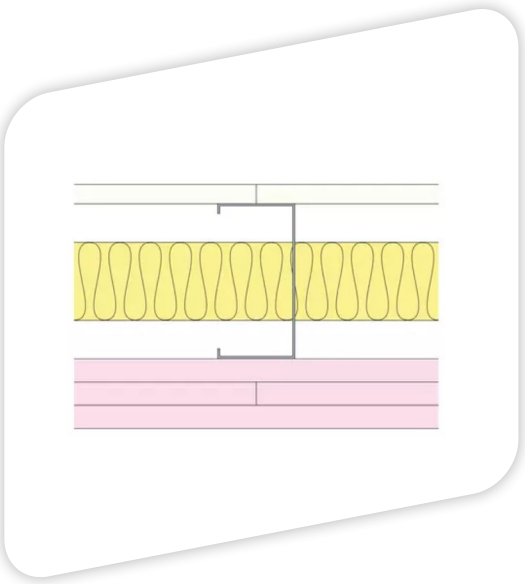

Gyproc Facade System T106022 (EN)

A non-loadbearing external wall construction including a 20mm deflection head with an inner layer of Glasroc X Sheathing Board 12.5mm to external side and three layers of Gyproc FireLine 15mm to the internal side of 100mm Gypframe metal stud framework. 50mm Isover Acoustic Insulation in the cavity. For heights up to 4000mm

| | | | | | | | |
|-----------------|-----|-----------------------|-----|---------------------|------|-------------------------------------|----|
| Fire Insulation | 120 | Fire Integrity (mins) | 120 | Maximum Height (mm) | 4000 | Sound Insulation (Airborne) Rw (dB) | 50 |
|-----------------|-----|-----------------------|-----|---------------------|------|-------------------------------------|----|

List of products

| | |
|-------------------------------|--|
| Board side 2 | Layer 1: Glasroc X Sheathing Board 12.5mm |
| Stud | 100mm Gyproc Facade Stud |
| Abutments and openings | 100mm Gyproc Facade Stud |
| Head channel | 104mm Gyproc Facade Slotted Head Track |
| Base channel | 104mm Gyproc Facade Base Track |
| Stud fixing | 5.5mm × 25mm course thread TEK screw |
| Insulation | Layer 1: 50mm Isover Acoustic Insulation |
| Board side 1 | Layer 1: Gyproc FireLine 15mm Layer 2: Gyproc FireLine 15mm Layer 3: Gyproc FireLine 15mm |
| Screws side 1 | Layer 1: Gyproc Jack-Point Screws 25mm Layer 2: Gyproc Jack-Point Screws 41mm Layer 3: Gyproc Jack-Point Screws 60mm |
| Screws side 2 | Layer 1: Glasroc X Screws 25mm |
| External board joints | Glasroc X Sealant |
| Sealant | Gyproc Sealant |
| Fixing strap | Gypframe GFS1 Fixing Strap |

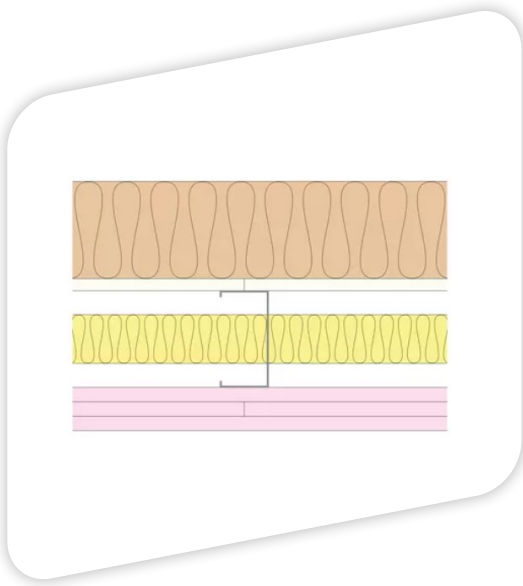

Gyproc Facade System T106023 (EN)

A non-loadbearing external wall construction including a 20mm deflection head with an inner layer of Glasroc X Sheathing Board 12.5mm and outer layer of 100mm Isover Polterm Max Plus Insulation to external side and three layers of Gyproc FireLine 15mm to the internal side of 100mm Gyproc Facade Stud framework. 50mm Isover Acoustic Insulation in the cavity. For heights up to 4000mm.

| | | | | | | | |
|-----------------|-----|-----------------------|-----|---------------------|------|--------------------------------------|----|
| Fire Insulation | 120 | Fire Integrity (mins) | 120 | Maximum Height (mm) | 4000 | Sound Insulation (Airbourne) Rw (dB) | 55 |
|-----------------|-----|-----------------------|-----|---------------------|------|--------------------------------------|----|

List of products

| | |
|-------------------------------|--|
| External insulation | Layer 1: 100mm Isover Polterm Max Plus |
| Board side 2 | Layer 1: Glasroc X Sheathing Board 12.5mm |
| Stud | 100mm Gyproc Facade Stud |
| Abutments and openings | 100mm Gyproc Facade Stud |
| Base channel | 104mm Gyproc Facade Base Track |
| Head channel | 104mm Gyproc Facade Slotted Head Track |
| Stud fixing | 5.5mm × 25mm course thread TEK screw |
| Insulation | Layer 1: 50mm Isover Acoustic Insulation |
| Board side 1 | Layer 1: Gyproc FireLine 15mm Layer 2: Gyproc FireLine 15mm Layer 3: Gyproc FireLine 15mm |
| Screws side 1 | Layer 1: Gyproc Jack-Point Screws 25mm Layer 2: Gyproc Jack-Point Screws 41mm Layer 3: Gyproc Jack-Point Screws 60mm |
| Screws side 2 | Layer 1: Glasroc X Screws 25mm |
| Sealant | Gyproc Sealant |
| External board joints | Glasroc X Sealant |
| Fixing strap | Gypframe GFS1 Fixing Strap |

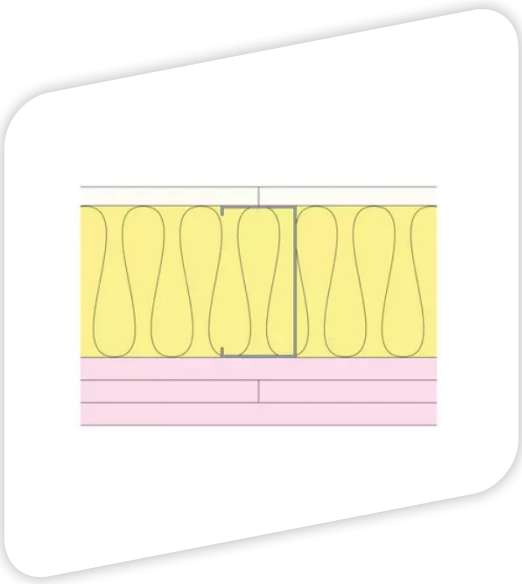

Gyproc Facade System T106030 (EN)

A non-loadbearing external wall construction including a 20mm deflection head with one layer of Glasroc X Sheathing Board 12.5mm to external side and three layers of Gyproc FireLine 15mm to the internal side of 100mm Gyproc Facade Stud framework. 100mm Isover Steel Frame Infill Batt in the cavity. For heights up to 4000mm.

| | | | | | |
|-----------------|-----|-----------------------|-----|---------------------|------|
| Fire Insulation | 120 | Fire Integrity (mins) | 120 | Maximum Height (mm) | 4000 |
|-----------------|-----|-----------------------|-----|---------------------|------|

List of products

| | |
|-------------------------------|---|
| Board side 2 | Layer 1: Glasroc X Sheathing Board 12.5mm |
| Stud | 100mm Gyproc Facade Stud |
| Base channel | 104mm Gyproc Facade Base Track |
| Head channel | 104mm Gyproc Facade Slotted Head Track |
| Abutments and openings | 100mm Gyproc Facade Stud |
| Stud fixing | 5.5mm x 25mm course thread TEK screw |
| Insulation | Layer 1: 100mm Isover Steel Frame Infill Batt |
| Board side 1 | Layer 1: Gyproc FireLine 15mm |
| | Layer 2: Gyproc FireLine 15mm |
| | Layer 3: Gyproc FireLine 15mm |
| Screws side 1 | Layer 1: Gyproc Jack-Point Screws 25mm |
| | Layer 2: Gyproc Jack-Point Screws 41mm |
| | Layer 3: Gyproc Jack-Point Screws 60mm |
| Screws side 2 | Layer 1: Glasroc X Screws 25mm |
| External board joints | Glasroc X Sealant |
| Sealant | Gyproc Sealant |
| Fixing strap | Gypframe GFS1 Fixing Strap |

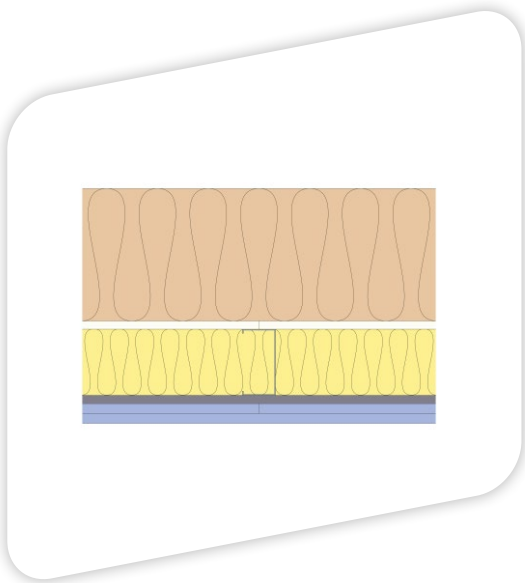

Gyproc Facade System T106036 (EN)

A non-loadbearing external wall construction including a 20mm deflection head with an inner layer of Glasroc X Sheathing Board 12.5mm and an outer of 200mm Isover Polterm Max Plus Insulation to the external side with an inner layer of Gyproc Habito 12.5mm and two outer layers of Gyproc SoundBloc 15mm to the internal side of 100mm Gyproc Facade Stud framework. 100mm Isover Acoustic Insulation in the cavity. For heights up to 3000mm.

| | | | | | |
|-----------------|-----|-----------------------|-----|---------------------|------|
| Fire Insulation | 120 | Fire Integrity (mins) | 120 | Maximum Height (mm) | 3000 |
|-----------------|-----|-----------------------|-----|---------------------|------|

List of products

| | |
|-------------------------------|--|
| External insulation | Layer 1: 200mm Isover Polterm Max Plus |
| Board side 2 | Layer 1: Glasroc X Sheathing Board 12.5mm |
| Stud | 100mm Gyproc Facade Stud |
| Head channel | 104mm Gyproc Facade Slotted Head Track |
| Base channel | 104mm Gyproc Facade Base Track |
| Abutments and openings | 100mm Gyproc Facade Stud |
| Stud fixing | 5.5mm × 25mm course thread TEK screw |
| Insulation | Layer 1: 100mm Isover Acoustic Insulation |
| Board side 1 | Layer 1: Gyproc Habito 12.5mm Layer 2: Gyproc SoundBloc 15mm Layer 3: Gyproc SoundBloc 15mm |
| Screws side 2 | Layer 1: Glasroc X Screws 25mm |
| Screws side 1 | Layer 1: Gyproc Jack-Point Screws 25mm Layer 2: Gyproc Jack-Point Screws 41mm Layer 3: Gyproc Jack-Point Screws 60mm |
| External board joints | Glasroc X Sealant |
| Sealant | Gyproc Sealant |
| Fixing strap | Gypframe GFS1 Fixing Strap |



SYSTEMS

**90mins Fire
Resistance**

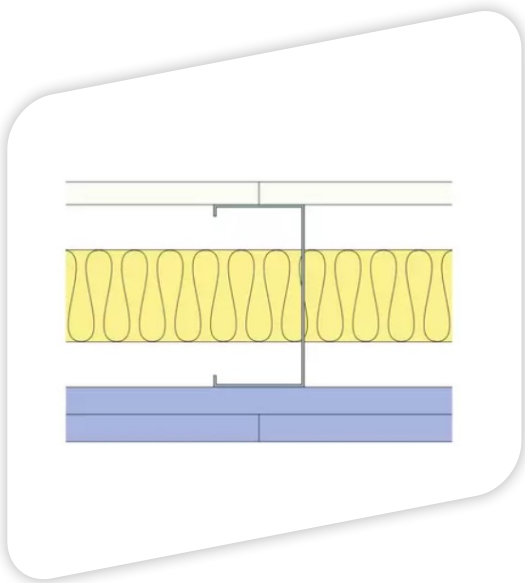

Gyproc Facade System T106019 (EN)

A non-loadbearing external wall construction including a 20mm deflection head with one layer of Glasroc X Sheathing Board 12.5mm to external side and two layers of Gyproc SoundBloc 15mm to the internal side of 100mm Gyproc Facade Stud framework. 50mm Isover Acoustic Insulation in the cavity. For heights up to 3000mm.

| | | | | | | | |
|-----------------|----|-----------------------|----|---------------------|------|-------------------------------------|----|
| Fire Insulation | 90 | Fire Integrity (mins) | 90 | Maximum Height (mm) | 3000 | Sound Insulation (Airborne) Rw (dB) | 51 |
|-----------------|----|-----------------------|----|---------------------|------|-------------------------------------|----|

List of products

| | |
|-------------------------------|---|
| Board side 2 | Layer 1: Glasroc X Sheathing Board 12.5mm |
| Stud | 100mm Gyproc Facade Stud |
| Base channel | 104mm Gyproc Facade Base Track |
| Head channel | 104mm Gyproc Facade Slotted Head Track |
| Abutments and openings | 100mm Gyproc Facade Stud |
| Stud fixing | 5.5mm × 25mm course thread TEK screw |
| Board side 1 | Layer 1: Gyproc SoundBloc 15mm Layer 2: Gyproc SoundBloc 15mm |
| Screws side 1 | Layer 1: Gyproc Jack-Point Screws 25mm Layer 2: Gyproc Screws 41mm |
| Screws side 2 | Layer 1: Glasroc X Screws 25mm |
| Insulation | Layer 1: 50mm Isover Acoustic Insulation |
| Sealant | Gyproc Sealant |
| External board joints | Glasroc X Sealant |
| Fixing strap | Gypframe GFS1 Fixing Strap |

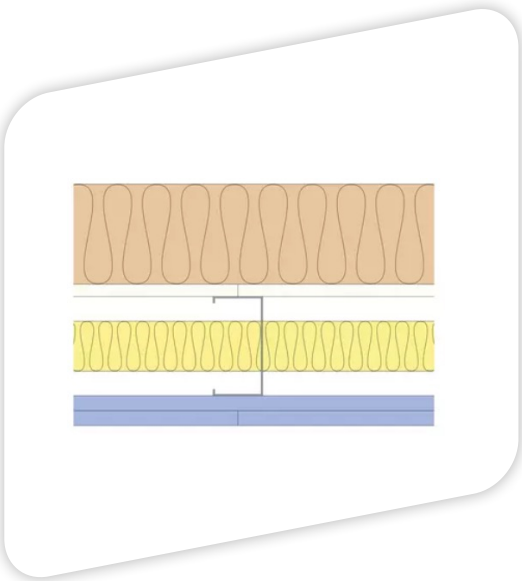

Gyproc Facade System T106021 (EN)

A non-loadbearing external wall construction including a 20mm deflection head with an inner layer of Glasroc X Sheathing Board 12.5mm and outer layer of 100mm Isover Polterm Max Plus Insulation to external side and two layers of Gyproc SoundBloc 15mm to the internal side of 100mm Gyproc Facade Stud framework. 50mm Isover Acoustic Insulation in the cavity. For heights up to 4000mm.

| | | | | | | | |
|-----------------|----|-----------------------|----|---------------------|------|--------------------------------------|----|
| Fire Insulation | 90 | Fire Integrity (mins) | 90 | Maximum Height (mm) | 4000 | Sound Insulation (Airbourne) Rw (dB) | 56 |
|-----------------|----|-----------------------|----|---------------------|------|--------------------------------------|----|

List of products

| | |
|-------------------------------|--|
| External insulation | Layer 1: 100mm Isover Polterm Max Plus |
| Board side 2 | Layer 1: Glasroc X Sheathing Board 12.5mm |
| Base channel | 104mm Gyproc Facade Base Track |
| Head channel | 104mm Gyproc Facade Slotted Head Track |
| Stud | 100mm Gyproc Facade Stud |
| Abutments and openings | 100mm Gyproc Facade Stud |
| Stud fixing | 5.5mm × 25mm course thread TEK screw |
| Insulation | Layer 1: 50mm Isover Acoustic Insulation |
| Board side 1 | Layer 1: Gyproc SoundBloc 15mm Layer 2: Gyproc SoundBloc 15mm |
| Screws side 1 | Layer 1: Gyproc Jack-Point Screws 25mm Layer 2: Gyproc Jack-Point Screws 41mm |
| Screws side 2 | Layer 1: Glasroc X Screws 25mm |
| External board joints | Glasroc X Sealant |
| Sealant | Gyproc Sealant |
| Fixing strap | Gypframe GFS1 Fixing Strap |

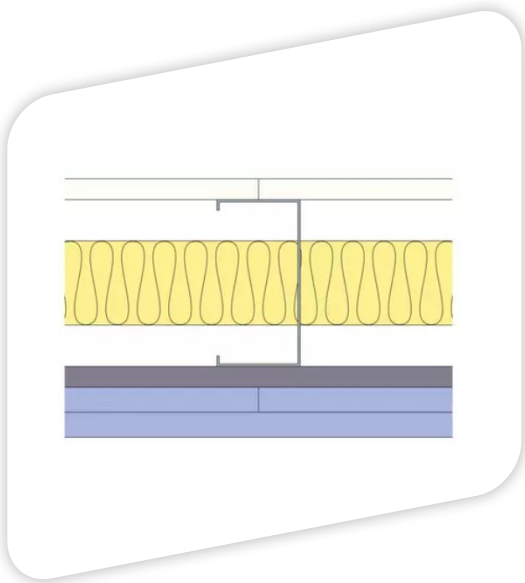

Gyproc Facade System T106033 (EN)

A non-loadbearing external wall construction including a 20mm deflection head with one layer of Glasroc X Sheathing Board 12.5mm to external side an inner layer of Gyproc Habito 12.5mm and two outer layers of Gyproc SoundBloc 15mm to the internal side of 100mm Gypframe metal stud framework. 50mm Isover Acoustic Insulation in the cavity. For heights up to 3000mm.

| | | | | | | | |
|-----------------|----|-----------------------|----|---------------------|------|--------------------------------------|----|
| Fire Insulation | 90 | Fire Integrity (mins) | 90 | Maximum Height (mm) | 3000 | Sound Insulation (Airbourne) Rw (dB) | 51 |
|-----------------|----|-----------------------|----|---------------------|------|--------------------------------------|----|

List of products

| | |
|-------------------------------|--|
| Board side 2 | Layer 1: Glasroc X Sheathing Board 12.5mm |
| Stud | 100mm Gyproc Facade Stud |
| Head channel | 104mm Gyproc Facade Slotted Head Track |
| Base channel | 104mm Gyproc Facade Base Track |
| Abutments and openings | 100mm Gyproc Facade Stud |
| Stud fixing | 5.5mm × 25mm course thread TEK screw |
| Insulation | Layer 1: 50mm Isover Acoustic Insulation |
| Board side 1 | Layer 1: Gyproc Habito 12.5mm Layer 2: Gyproc SoundBloc 15mm Layer 3: Gyproc SoundBloc 15mm |
| Screws side 1 | Layer 1: Gyproc Jack-Point Screws 25mm Layer 2: Gyproc Jack-Point Screws 41mm Layer 3: Gyproc Jack-Point Screws 60mm |
| Screws side 2 | Layer 1: Glasroc X Screws 25mm |
| External board joints | Glasroc X Sealant |
| Sealant | Gyproc Sealant |
| Fixing strap | Gypframe GFS1 Fixing Strap |

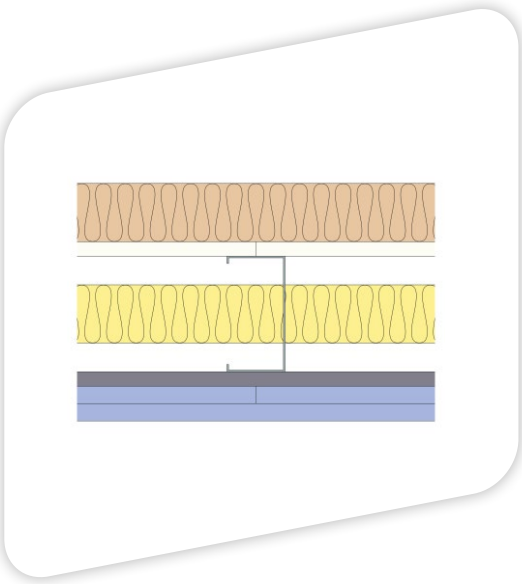

Gyproc Facade System T106034 (EN)

A non-loadbearing external wall construction including a 20mm deflection head with an inner layer of Glasroc X Sheathing Board 12.5mm and outer layer of 50mm Isover Polterm Max Plus Insulation to external side an inner layer of Gyproc Habito 12.5mm and two outer layers Gyproc SoundBloc 15mm to the internal side of 100mm Gyproc Facade Stud framework. 50mm Isover Acoustic Insulation in the cavity. For heights up to 4000mm.

| | | | | | | | |
|-----------------|----|-----------------------|----|---------------------|------|--------------------------------------|----|
| Fire Insulation | 90 | Fire Integrity (mins) | 90 | Maximum Height (mm) | 4000 | Sound Insulation (Airbourne) Rw (dB) | 51 |
|-----------------|----|-----------------------|----|---------------------|------|--------------------------------------|----|

List of products

| | |
|-------------------------------|--|
| External insulation | Layer 1: 50mm Isover Polterm Max Plus |
| Board side 2 | Layer 1: Glasroc X Sheathing Board 12.5mm |
| Stud | 100mm Gyproc Facade Stud |
| Abutments and openings | 100mm Gyproc Facade Stud |
| Head channel | 104mm Gyproc Facade Slotted Head Track |
| Base channel | 104mm Gyproc Facade Base Track |
| Stud fixing | 5.5mm × 25mm course thread TEK screw |
| Insulation | Layer 1: 50mm Isover Acoustic Insulation |
| Board side 1 | Layer 1: Gyproc Habito 12.5mm Layer 2: Gyproc SoundBloc 15mm Layer 3: Gyproc SoundBloc 15mm |
| Screws side 1 | Layer 1: Gyproc Jack-Point Screws 25mm Layer 2: Gyproc Jack-Point Screws 41mm Layer 3: Gyproc Jack-Point Screws 60mm |
| Screws side 2 | Layer 1: Glasroc X Screws 25mm |
| External board joints | Glasroc X Sealant |
| Sealant | Gyproc Sealant |
| Fixing strap | Gypframe GFS1 Fixing Strap |

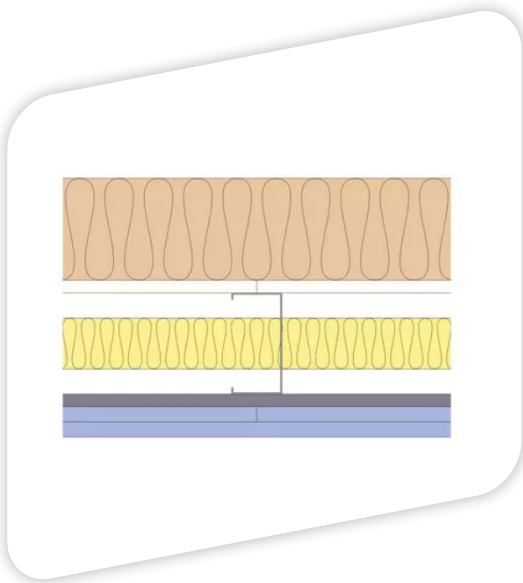

Gyproc Facade System T106035 (EN)

A non-loadbearing external wall construction including a 20mm deflection head with an inner layer of Glasroc X Sheathing Board 12.5mm and outer layer of 100mm Isover Polterm Max Plus Insulation to external side an inner layer of Gyproc Habito 12.5mm and two outer layers of Gyproc SoundBloc 15mm to the internal side of 100mm Gypframe metal stud framework. 50mm Isover Acoustic Insulation in the cavity. For heights up to 3000mm.

| | | | | | | | |
|-----------------|----|-----------------------|----|---------------------|------|--------------------------------------|----|
| Fire Insulation | 90 | Fire Integrity (mins) | 90 | Maximum Height (mm) | 4000 | Sound Insulation (Airbourne) Rw (dB) | 56 |
|-----------------|----|-----------------------|----|---------------------|------|--------------------------------------|----|

List of products

| | |
|-------------------------------|--|
| External insulation | Layer 1: 100mm Isover Polterm Max Plus |
| Board side 2 | Layer 1: Glasroc X Sheathing Board 12.5mm |
| Stud | 100mm Gyproc Facade Stud |
| Head channel | 104mm Gyproc Facade Slotted Head Track |
| Base channel | 104mm Gyproc Facade Base Track |
| Abutments and openings | 100mm Gyproc Facade Stud |
| Stud fixing | 5.5mm × 25mm course thread TEK screw |
| Insulation | Layer 1: 50mm Isover Acoustic Insulation |
| Board side 1 | Layer 1: Gyproc Habito 12.5mm Layer 2: Gyproc SoundBloc 15mm Layer 3: Gyproc SoundBloc 15mm |
| Screws side 1 | Layer 1: Gyproc Jack-Point Screws 25mm Layer 2: Gyproc Jack-Point Screws 41mm Layer 3: Gyproc Jack-Point Screws 60mm |
| Screws side 2 | Layer 1: Glasroc X Screws 25mm |
| External board joints | Glasroc X Sealant |
| Sealant | Gyproc Sealant |
| Fixing strap | Gypframe GFS1 Fixing Strap |



SYSTEMS

**60mins Fire
Resistance**

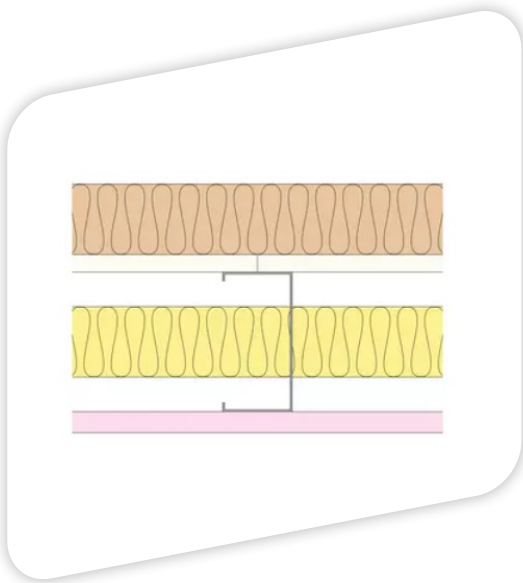

Gyproc Facade System T106017 (EN)

A non-loadbearing external wall construction, including a 20mm deflection head, with an inner layer of Glasroc X Sheathing Board 12.5mm and outer layer of 50mm Isover Polterm Max Plus Insulation to external side and one layer of Gyproc FireLine 15mm to the internal side of 100mm Gypframe infill stud framework. 50mm Isover Acoustic Insulation in the cavity. For heights up to 4000mm.

| | | | | | | | |
|-----------------|----|-----------------------|----|---------------------|------|--------------------------------------|----|
| Fire Insulation | 60 | Fire Integrity (mins) | 60 | Maximum Height (mm) | 4000 | Sound Insulation (Airbourne) Rw (dB) | 47 |
|-----------------|----|-----------------------|----|---------------------|------|--------------------------------------|----|

List of products

| | |
|-------------------------------|---|
| External insulation | Layer 1: 50mm Isover Polterm Max Plus |
| Board side 2 | Layer 1: Glasroc X Sheathing Board 12.5mm |
| Stud | 100mm Gyproc Facade Stud |
| Base channel | 104mm Gyproc Facade Base Track |
| Head channel | 104mm Gyproc Facade Slotted Head Track |
| Abutments and openings | 100mm Gyproc Facade Stud |
| Stud fixing | 5.5mm × 25mm course thread TEK screw |
| Insulation | Layer 1: 50mm Isover Acoustic Insulation |
| Board side 1 | Layer 1: Gyproc FireLine 15mm |
| Screws side 2 | Layer 1: Glasroc X Screws 25mm |
| Screws side 1 | Layer 1: Gyproc Jack-Point Screws 25mm |
| External board joints | Glasroc X Sealant |
| Sealant | Gyproc Sealant |
| Fixing strap | Gypframe GFS1 Fixing Strap |

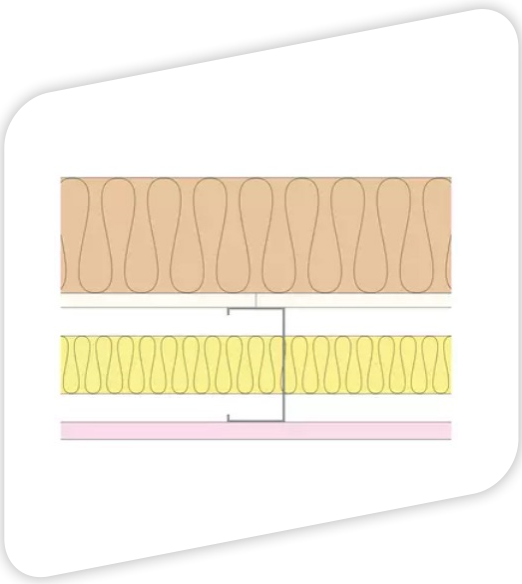

Gyproc Facade System T106018 (EN)

A non-loadbearing external wall construction, including a 20mm deflection head, with an inner layer of Glasroc X Sheathing Board 12.5mm and outer layer of 100mm Isover Polterm Max Plus Insulation to external side and one layer of Gyproc FireLine 15mm to the internal side of 100mm Gypframe infill stud framework. 50mm Isover Acoustic Insulation in the cavity. For heights up to 4000mm.

| | | | | | | | |
|-----------------|----|-----------------------|----|---------------------|------|-------------------------------------|----|
| Fire Insulation | 60 | Fire Integrity (mins) | 60 | Maximum Height (mm) | 4000 | Sound Insulation (Airborne) Rw (dB) | 52 |
|-----------------|----|-----------------------|----|---------------------|------|-------------------------------------|----|

List of products

| | |
|-------------------------------|---|
| External insulation | Layer 1: 100mm Isover Polterm Max Plus |
| Board side 2 | Layer 1: Glasroc X Sheathing Board 12.5mm |
| Stud | 100mm Gyproc Stud |
| Base channel | 104mm Gyproc Facade Base Track |
| Head channel | 104mm Gyproc Facade Slotted Head Track |
| Abutments and openings | 100mm Gyproc Stud |
| Stud fixing | 5.5mm × 25mm course thread TEK screw |
| Insulation | Layer 1: 50mm Isover Acoustic Insulation |
| Board side 1 | Layer 1: Gyproc FireLine 15mm |
| Screws side 1 | Layer 1: Gyproc Jack-Point Screws 25mm |
| Screws side 2 | Layer 1: Glasroc X Screws 25mm |
| External board joints | Glasroc X Sealant |
| Sealant | Gyproc Sealant |
| Fixing strap | Gypframe GFS1 Fixing Strap |

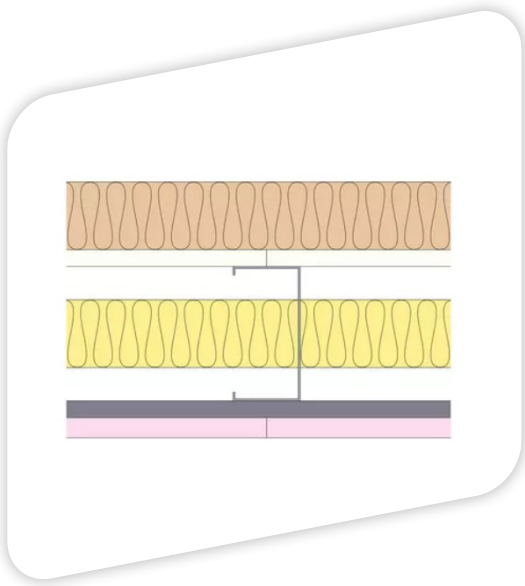

Gyproc Facade System T106031 (EN)

A non-loadbearing external wall construction including a 20mm deflection head with an inner layer of Glasroc X Sheathing Board 12.5mm and outer layer of 50mm Isover Polterm Max Plus Insulation to external side an inner layer of Gyproc Habito 12.5mm and outer layer Gyproc FireLine 15mm to the internal side of 100mm Gypframe infill stud framework. 50mm Isover Acoustic Insulation in the cavity. For heights up to 4000mm.

| | | | | | | | |
|-----------------|----|-----------------------|----|---------------------|------|--------------------------------------|----|
| Fire Insulation | 60 | Fire Integrity (mins) | 60 | Maximum Height (mm) | 4000 | Sound Insulation (Airbourne) Rw (dB) | 47 |
|-----------------|----|-----------------------|----|---------------------|------|--------------------------------------|----|

List of products

| | |
|-------------------------------|--|
| External insulation | Layer 1: 50mm Isover Polterm Max Plus |
| Board side 2 | Layer 1: Glasroc X Sheathing Board 12.5mm |
| Stud | 100mm Gyproc Facade Stud |
| Abutments and openings | 100mm Gyproc Facade Stud |
| Head channel | 104mm Gyproc Facade Slotted Head Track |
| Base channel | 104mm Gyproc Facade Base Track |
| Stud fixing | 5.5mm × 25mm course thread TEK screw |
| Insulation | Layer 1: 50mm Isover Acoustic Insulation |
| Board side 1 | Layer 1: Gyproc Habito 12.5mm Layer 2: Gyproc FireLine 15mm |
| Screws side 1 | Layer 1: Gyproc Jack-Point Screws 25mm Layer 2: Gyproc Jack-Point Screws 41mm |
| Screws side 2 | Layer 1: Glasroc X Screws 25mm |
| Sealant | Gyproc Sealant |
| External board joints | Glasroc X Sealant |
| Fixing strap | Gypframe GFS1 Fixing Strap |

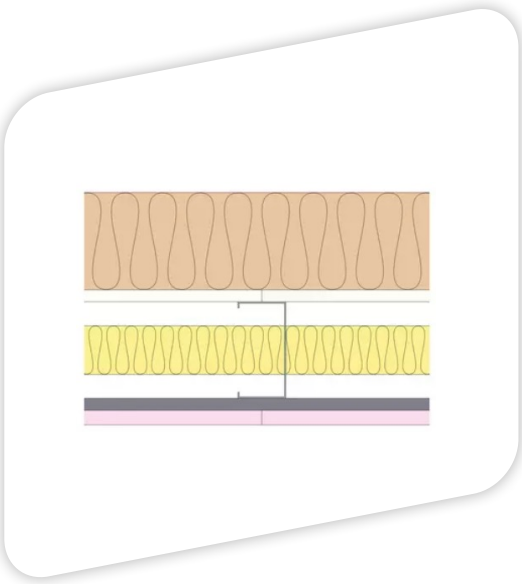

Gyproc Facade System T106032 (EN)

A non-loadbearing external wall construction including a 20mm deflection head with an inner layer of Glasroc X Sheathing Board 12.5mm and outer layer of 100mm Isover Polterm Max Plus Insulation to external side an inner layer of Gyproc Habito 12.5mm and outer layer Gyproc FireLine 15mm to the internal side of 100mm Gypframe infill stud framework. 50mm Isover Acoustic Insulation. For heights up to 4000mm.

| | | | | | | | |
|-----------------|----|-----------------------|----|---------------------|------|--------------------------------------|----|
| Fire Insulation | 60 | Fire Integrity (mins) | 60 | Maximum Height (mm) | 4000 | Sound Insulation (Airbourne) Rw (dB) | 52 |
|-----------------|----|-----------------------|----|---------------------|------|--------------------------------------|----|

List of products

| | |
|-------------------------------|--|
| External insulation | Layer 1: 100mm Isover Polterm Max Plus |
| Board side 2 | Layer 1: Glasroc X Sheathing Board 12.5mm |
| Stud | 100mm Gyproc Facade Stud |
| Head channel | 104mm Gyproc Facade Slotted Head Track |
| Base channel | 104mm Gypframe Channel |
| Abutments and openings | 100mm Gyproc Facade Stud |
| Stud fixing | 5.5mm × 25mm course thread TEK screw |
| Insulation | Layer 1: 50mm Isover Acoustic Insulation |
| Board side 1 | Layer 1: Gyproc Habito 12.5mm Layer 2: Gyproc FireLine 15mm |
| Screws side 1 | Layer 1: Gyproc Jack-Point Screws 25mm Layer 2: Gyproc Jack-Point Screws 41mm |
| Screws side 2 | Layer 1: Glasroc X Screws 25mm |
| External board joints | Glasroc X Sealant |
| Sealant | Gyproc Sealant |
| Fixing strap | Gypframe GFS1 Fixing Strap |

MEET THE NEW PLAYER IN EXTERIOR INSULATION



ISOVER POLTERM MAX PLUS

Non-combustible stone wool insulation sheathed in a black glass veil for high performance and a classy finish.



THERMAL
0.035 W/mK



NON-COMBUSTIBLE
Euroclass A1 making it suitable for projects above and below 18m in height



WATER REPELLENT
Moisture Ingress Protection



NON-COMBUSTIBLE
External Noise Reduction



Designed to integrate with ISOVER intelligent membranes and internal insulation

PERFECT FOR VENTILATED
RAINSREEN CLADDING AND
OVERCLADDING SYSTEMS

MOVE BY MOVE, WE'RE HERE

www.isover.ie

SCAN FOR MORE
INFORMATION

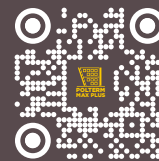

Gyproc Facade System

Construction Details

The following pages highlight key examples of available construction details. Further details are available to support your project and optimise performance.

1. Typical deflection detail - tested for up to 120 mins (inside-to-out)

Indicative concrete slab

Gyproc Sealant for optimum sound insulation

Indicative external cladding with appropriate cavity barriers where required

Gypframe GA4 Steel Angle fixed to steel beam at max. 600mm centres

Gypframe MF6 Perimeter Channel suitably fixed to soffit at max. 600mm centres

Indicative intumescent painted beam

20mm joint sealed with 60mm wide Illbruck ME010 breather membrane tape secured with 2 beads of Illbruck SP025 adhesive (top and bottom)

Indicative 'Z' bars sized and supplied by others at 300mm centres and suitably fixed to beam

Cavity barrier (indicative) where required. Defined and specified by others

Gypframe slotted head track suitably fixed to 'Z' bars in accordance with manufacturer's instructions

Gypframe GA4 Steel Angle suitably fixed to 'Z' bars with Gyproc Wafer Head Drywall Screw

Gypframe GFS1 Fixing Strap to receive uppermost board fixings (no fixings into head channel)

Indicative stone wool insulation by others (45kg/m³)

50mm Isover Acoustic Insulation

Gypframe GA2 Steel Angle pre-fixed to MF6 Perimeter Channel with Gyproc Wafer Head Drywall Screw at max. 600mm centres

Gypframe GA4 Steel Angle fixed through plasterboard to angle with Gyproc Drywall Screw

Gypframe infill stud installed in accordance with manufacturer's instructions

We can provide details to fully encase all structural steel. It may be possible through third party assessment of test data (by a suitably qualified structural or fire engineer) to determine whether the conditions offered by the lining are sufficient to protect hot rolled elements, without the need for additional fire protection measures.



Details for 60 and 90 minute fire resistance available

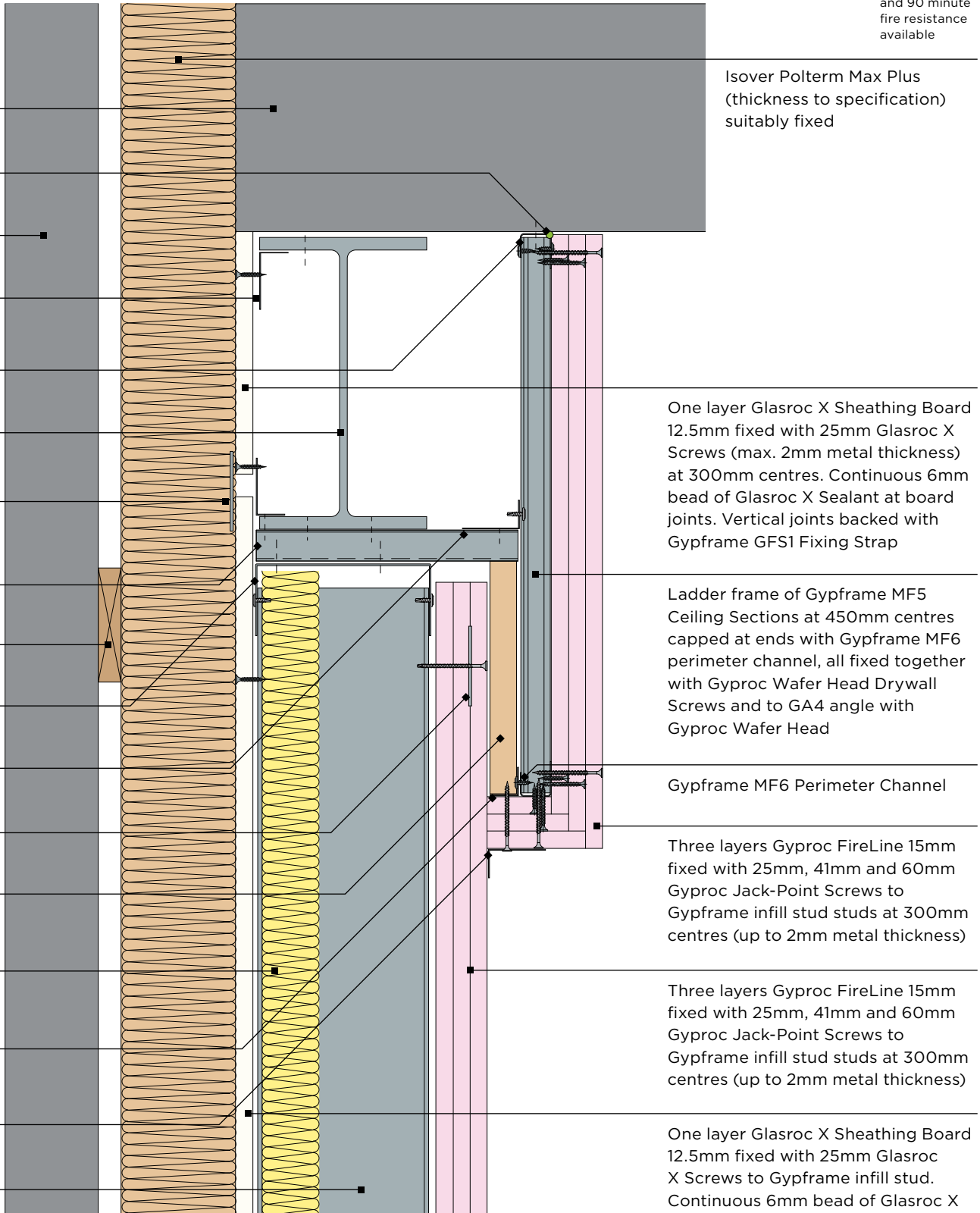

Gyproc Facade System Construction Details

2. Junction with external wall

Gypframe infill studs at specified centres

Isover insulation to meet thermal requirements

One layer Glasroc X Sheathing Board 12.5mm fixed with 25mm Glasroc X Screws (max. 2mm metal thickness) at 300mm centres. Continuous 6mm bead of Glasroc X Sealant at board joints

Glasroc X Sealant

Gypframe 'C' Studs where required

Isover insulation to meet acoustic requirements

Cavity barrier (indicative) where required defined and specified by others

Indicative external finish

Additional Gypframe infill stud at junction

Gypframe 'C' stud fixed through board to Gypframe infill stud with suitable screws (Gyproc Jack-Point screws max. 2mm metal thickness) at 600mm centres (in two lines staggered by 300mm for 92mm and 146mm studs)

Isover Polterm Max Plus (thickness to specification) suitably fixed

One layer Gyproc plasterboard or Glasroc specialist board fixed with suitable Gyproc screws at 300mm centres (200mm centres at external angles)

One layer Gyproc FireLine 15mm fixed with 25mm Gyproc Jack-Point screws (max. 2mm metal thickness) at 300mm centres



Details for 30 and 60 minute fire resistance available

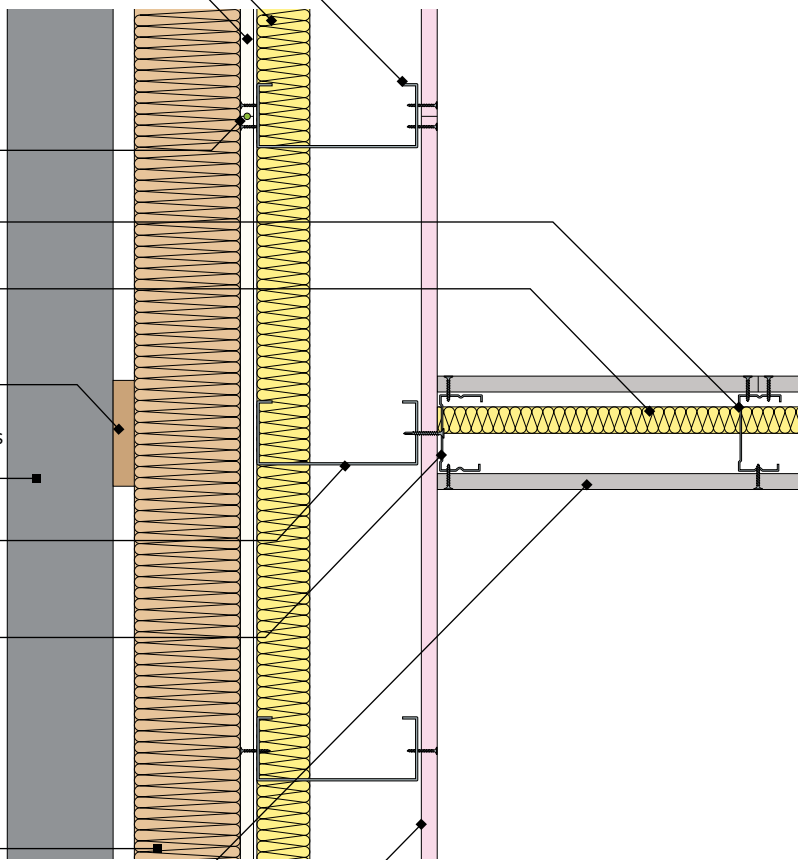

We can provide details to fully encase all structural steel. It may be possible through third party assessment of test data (by a suitably qualified structural or fire engineer) to determine whether the conditions offered by the lining are sufficient to protect hot rolled elements, without the need for additional fire protection measures.

3. GypWall Twin Frame Independent junction with Gypframe infill external wall



Details for 60 and 90 minute fire resistance available

Gypframe infill studs at specified centres

Isover insulation to meet thermal requirements

One layer Glasroc X Sheathing Board 12.5mm fixed with 25mm Glasroc X Screws (max. 2mm metal thickness) at 300mm centres. Continuous 6mm bead of Glasroc X Sealant at board joints

Glasroc X Sealant

Isover Polterm Max Plus (thickness to specification) suitably fixed

Cavity barrier (indicative) where required. Defined and specified by others

Indicative external finish

Stone mineral wool 100kg/m³ minimum density by others

Additional Gypframe 'C' stud at junction

Gypframe 'C' stud fixed through board to stud with suitable Gyproc screws at 600mm centres

Two layers Gyproc plasterboard or Glasroc specialist board fixed with suitable Gyproc screws at 300mm centres (200mm centres at external angles)

Isover insulation to meet requirements

Two layers Gyproc SoundBloc 15mm fixed with 25mm and 41mm Gyproc Jack-Point screws at 300mm centres

Two lines of Gypframe 'I' Studs at specified centres

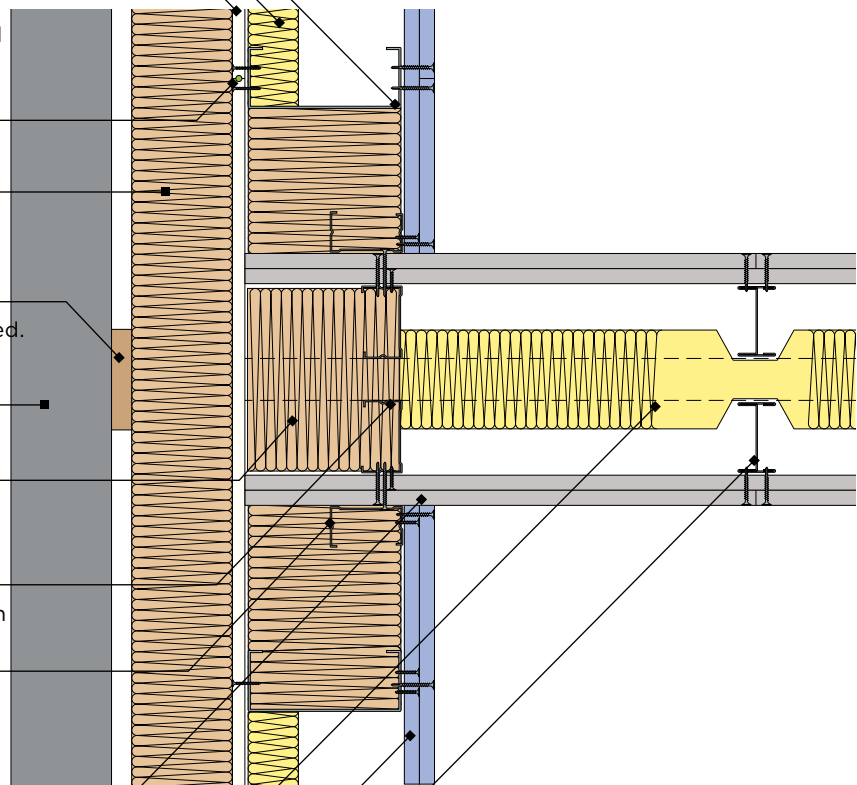

We can provide details to fully encase all structural steel. It may be possible through third party assessment of test data (by a suitably qualified structural or fire engineer) to determine whether the conditions offered by the lining are sufficient to protect hot rolled elements, without the need for additional fire protection measures.

Gyproc Facade System

Construction Details

4. Window reveal

Indicative window frame independently supported by the Gypframe infill stud framework

Cavity barrier where required.

Indicative external finish

Isover Polterm Max Plus suitably fixed through board to Gypframe infill stud

One layer Glasroc X Sheathing Board 12.5mm fixed with 25mm Glasroc X Screws (max. 2mm metal thickness) at 300mm centres. Continuous 6mm bead of Glasroc X Sealant at board joints

Isover insulation to meet thermal requirements

Gypframe infill studs at specified centres installed in accordance with manufacturer's instructions

One or two layers Gyproc plasterboard or Glasroc specialist board fixed with Gyproc Jack-Point screws (max. 2mm metal thickness) at 300mm centres (200mm centres at external angles)

Gyproc Sealant for optimum sound insulation

Indicative window cill

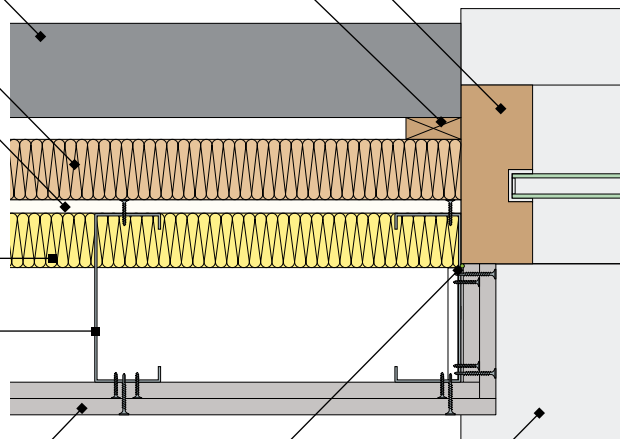

We can provide details to fully encase all structural steel. It may be possible through third party assessment of test data (by a suitably qualified structural or fire engineer) to determine whether the conditions offered by the lining are sufficient to protect hot rolled elements, without the need for additional fire protection measures.

5. Window head and cill

Gypframe infill studs at specified centres installed in accordance with manufacturer's instructions

Isover insulation to meet thermal requirements

Isover Polterm Max Plus suitably fixed through board to Gypframe infill stud

One or two layers Gyproc plasterboard or Glasroc specialist board fixed with Gyproc Jack-Point screws (max. 2mm metal thickness) at 300mm centres (200mm centres at external angles)

Indicative window cill

Gyproc Sealant for sound insulation

Indicative window frame independently supported by the Gypframe infill stud framework

Cavity barrier where required

One layer Glasroc X Sheathing Board 12.5mm fixed with 25mm Glasroc X Screws (max. 2mm metal thickness) at 300mm centres. Continuous 6mm bead of Glasroc X Sealant at board joints

Indicative external finish

Gypframe infill channel installed in accordance with manufacturer's instructions

One or two layers Gyproc plasterboard or Glasroc specialist board fixed with Gyproc Jack-Point screws (max. 2mm metal thickness) at 300mm centres (200mm centres at external angles)

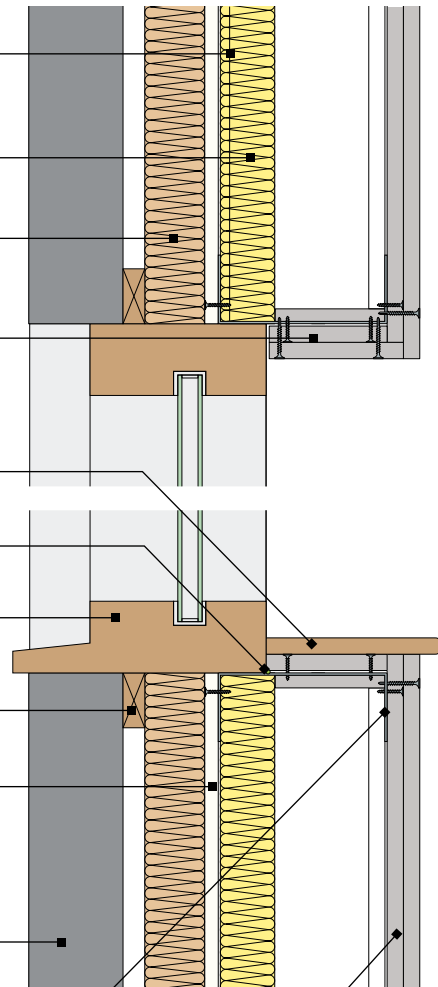

We can provide details to fully encase all structural steel. It may be possible through third party assessment of test data (by a suitably qualified structural or fire engineer) to determine whether the conditions offered by the lining are sufficient to protect hot rolled elements, without the need for additional fire protection measures.



Looking for a bespoke solution?

Did you know that we offer the creation of bespoke length **Gyproc plasterboard** and **Gypframe metal products**?

Whether you require a non-standard length for Gypframe metal or alternative edge profile, vapour check or other specification changes for Gyproc plasterboards, we'll endeavour to provide you with the best possible solution, subject to manufacturing constraints.

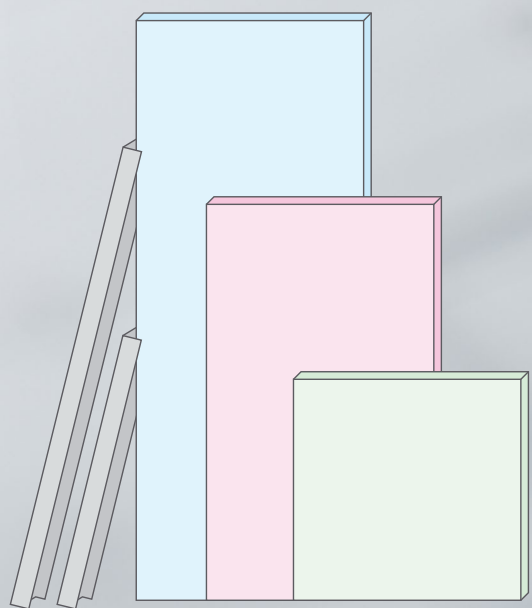

Benefits of bespoke products

By using Gyproc bespoke length products, significant **reductions in on-site cutting** means:

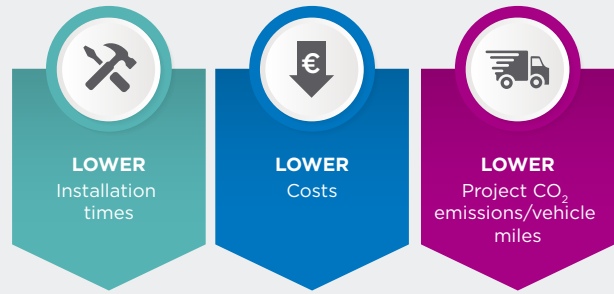

Talk to us about your project

You can discuss your project requirements for non-standard lengths of Gyproc plasterboard or Gypframe metal products with either your local Gyproc Area Sales Manager, or with our Technical Team on Free Phone ROI 1800 744480 / NI 0845 3990159.

Terms and Conditions Apply

Please note that special Terms and Conditions apply for bespoke product orders regarding the placing of orders, lead times and delivery:

- Minimum order quantities apply.
- All bespoke product orders require a written irrevocable order.
- Lead time applies from when product availability is confirmed by Customer Service.
- Subject to manufacturing constraints.
- All bespoke products not delivered within 30 days of manufacture will be invoiced in full.

Plasterboards

Any plasterboard product from our entire range is available as a bespoke order with the exception of the following: Plank, CoreBoard, Ceiling Products, Glasroc F MULTIBOARD, Glasroc F FIRECASE, Glasroc H TILEBACKER, Rigidur, Habito*, Glasroc X and Aquaroc.

Lead Time: 15 working days

Minimum Order: 1000 sheets

Metal

| Lead times: | up to 10 days: | up to 15 days: |
|---|------------------|------------------|
| Dependent on component for consistency | 48 S 50 'C' Stud | 60 I 50 'I' Stud |
| | 70 S 50 'C' Stud | 60 I 70 'I' Stud |
| | | 70 I 70 'I' Stud |

Minimum Length: 2400mm (excludes MF5)

Maximum Length: 8000mm (dependent on component)

Minimum Order: 1000LM (e.g. 2500mm x 400 lengths)

For all other components, due to case by case variables, lead times will be established at time of order.

If your customers are planning a project which could benefit from reduced plasterboard/metal waste, labour costs and vehicle movements, we can provide assistance at each stage of the process, get in touch now.



Contact Us

Contact your local Gyproc Area Sales Manager or our Technical Team on Free Phone:

ROI 1800 744480

NI 0845 3990159



Manufacturing locally, in Ireland, with over 80 years' experience in plaster, plasterboard and ceiling solutions, we have a multitude of high performance products and systems.

You'll find our plaster, plasterboard, metal and ceiling solutions in almost every kind of building in the country.

Our mission is to develop innovative products and services that help customers build better spaces to live work and play, making the world a better home.

We base our approach to business on the following; changing how we build, for the better, for the future; caring for the environment we operate within; supporting and developing our people; connecting with our communities and supporting their economic development.

In every kind of building - from home to work, from the local supermarket to the local hospital - we help create partitions, provide comfort, protect against fire and insulate against sound.

We are continually working to help our customers, suppliers and partners in the supply chain support more sustainable construction while we focus on developing more sustainable products, systems and services to add to our sustainability offering.

We recognise the social and environmental impacts of transportation, and the need to adopt appropriate strategies to reduce adverse impacts by actively assessing all viable methods of transport in and out of the business, for both product and people.

BES 6001

In addition to use in BREEAM, BES 6001 responsible sourcing certification has now been validated as a credit for use in LEED projects. BES 6001 'Excellent' has been achieved for our locally manufactured Gyproc plasters and plasterboard as well as Gypframe Metal, Glasroc F plasterboards and ISOVER insulation.

Volatile Organic Compounds

All locally manufactured Gyproc plasters and plasterboards have been assessed by Normec testing and demonstrates compliance with VOC requirements on low emitting products of French A+ class, German AgBB/ABG, BREEAM Int (exemplary level) and LEED EU. Testing was performed according to the latest versions of EN 16516 and ISO 16000 series by ISO/IEC 17025 accredited test laboratory Servaco/ Normec Product Testing.

Waste management and resource use

Our approach has been to adopt the waste hierarchy, and only use landfill as a last resort. Ensuring sustainable purchasing and minimising use of raw materials is an important part of our strategy. Dependence on virgin raw materials continues to be minimised through the use of reclaimed and recycled materials, and using resources in the most efficient manner. We have lead the industry in recycling plasterboard waste, reducing the pressure on landfill and preserving gypsum deposits. This has brought us to where we are today with the inclusion of up to 15% recycled content in our plasterboard manufacture process.

Nationwide Gyproc Plasterboard Recycling Service

Responsible waste management is a priority for us and we've always believed that effective waste management makes good environmental and business sense.

Gyproc along with our partner, Allied Recycling, has developed a cost-effective process to take back and recycle Gyproc plasterboard off-cuts. Allied Recycling will provide you with a traceability certificate which will be endorsed by Gyproc to prove that your plasterboard offcuts were 100% recycled back into the process - keeping you compliant with Irish law.

By managing your waste, we ensure you're adhering to EU Landfill Directive as dictated by Irish Law.

*Fully traceable
service endorsed
by Gyproc*

For more information

or to open an account with Allied Recycling please contact them at:

Allied Recycling

Unit 74, Naas Industrial Estate,
Naas, Co. Kildare.

Phone:
01 278 7080

Email:
naas@alliedrecycling.ie

Or through their national sales manager:

Kieran Kelly
Sales Manager

Mobile:
086 380 8602

Email:
kieran.kelly@alliedrecycling.ie

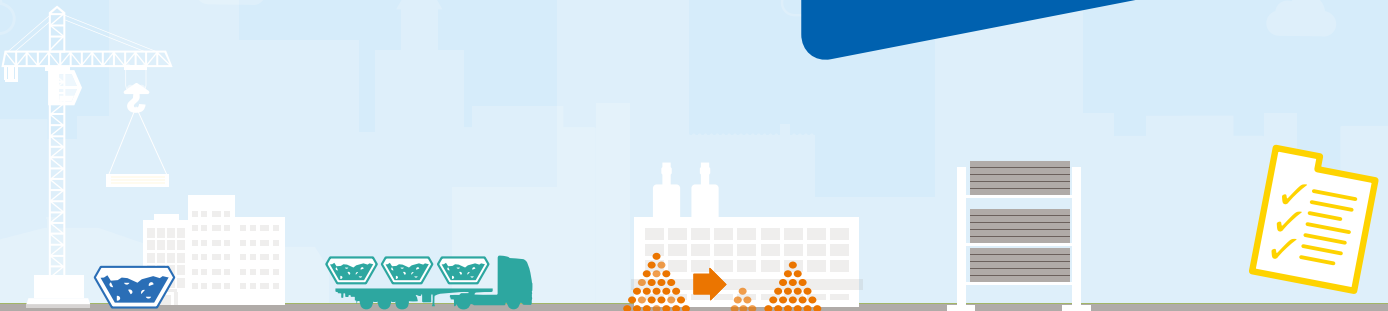

**Skip
Supplied**



**Skip
Collected**



**Recycling
Facility**



**100% Recycled
Plasterboard Off-Cuts**



**Traceability
Certificate**

Environmental Product Declarations



We want to make the selection of sustainable solutions simpler for our customers. In order to do this, we have begun developing Life Cycle Assessments (LCA) for our product ranges.

Since December 2013 we have published eleven Environmental Product Declarations (EPDs) across two brands, Gyproc and Isover. The independently verified EPDs, which are the result of the Life Cycle Assessment (LCA) process, are designed to give users information on the environmental performance of our products across numerous impact categories.

The underlying LCA considers the entire life cycle of a product solution from cradle-to-grave. As part of the assessment, a comprehensive range of factors are considered, including the potential environmental effects of raw materials,

the manufacturing process, logistics, installation, performance in use and finally the product at the end of its life. EPDs include information on raw material use, energy use and efficiency, content of materials and chemical substances, emissions to air, soil and water and waste generation – this enables our customers to understand the full environmental impacts of the product ranges being selected.

The EPD results also enable us to understand at which stage our products have the greatest impact on the environment. We can therefore make better informed decisions on processes involved in the production of current and new products, as well as taking steps to minimise the environmental impact of our products across their lifecycle. EPDs also provide clear evidence for environmental building certification schemes, meeting credit requirements in BREEAM, for example.



To quickly download any of our EPD's visit gyproc.ie or isover.ie

The BREEAM® Certification



What is BREEAM®?

BREEAM® (Building Research Establishment's Environmental Assessment Method) is an environmental assessment method for buildings, created in the UK in 1990.

It is the most important certification worldwide, regarding the number of certified buildings, with 200,000 buildings certified and over a million registered. BREEAM® has different schemes of certification, depending on the country, the building type (office building, retail etc.) and the construction type (new, refurbishment etc.).

Reference

BREEAM® International New Construction 2013 > This is the rating system that has been used as a reference in this document

BREEAM® 2011 for new construction of non-domestic buildings

BREEAM® UK Communities

BREEAM® UK In-Use

BREEAM® UK Refurbishment

EcoHomes (UK)

BREEAM® Europe Commercial

BREEAM® International Bespoke

BREEAM® Rating

Credits are awarded in 10 categories according to the performance of the building assessed. These credits are then added together to produce a single overall score.

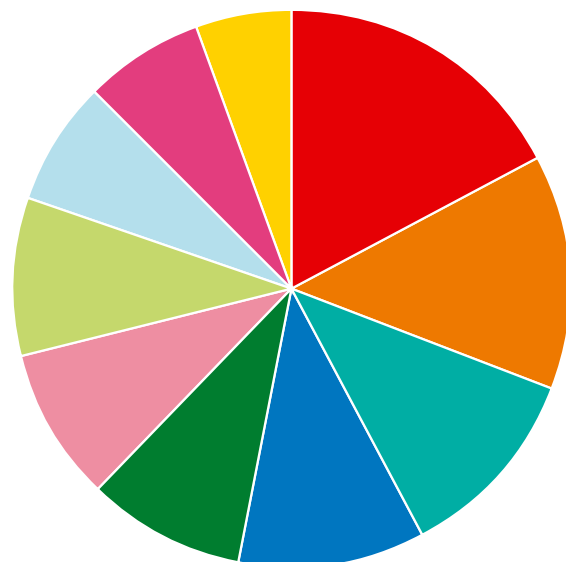

- Management 12%
- Health & Wellbeing 15%
- Energy 19%
- Transport 8%
- Water 6%
- Materials 12.5%
- Waste 7.5%
- Landuse and Ecology 10%
- Pollution 10%
- Innovation 10% bonus



To find out more about Gyproc and BREEAM visit gyproc.ie

LEED® Certification



What is LEED®?

LEED®, or Leadership in Energy & Environmental Design, is a green building certification programme that recognises best-in-class building strategies and practices.

LEED® provides rating systems that are voluntary, consensus-based, market-driven, and based on accepted energy and environmental principles. The LEED® rating systems were developed by US Green Building Council committees in 1998. In January 2015, there were more than 76,500 registered projects and 35,000 certified buildings¹.

To receive LEED® certification, building projects must satisfy prerequisites and earn points to achieve different levels of certification. Prerequisites and credits differ for each rating system, depending on the type of building (office, school, home, etc.) and the type of project (new or renovation). In total, there are five rating systems that address multiple project types.

The certification is developed by the US Green Building Council. As a platinum member of this organisation since September 2013, Saint-Gobain has become a key partner of LEED®. USGBC released a new version of the LEED® certification, called V4, at the end of 2013. This version will be the only one on the market from July 2015.

LEED® ratings

There are four rating systems that address multiple project types:

- Building Design and Construction
- Interior Design and Construction
- Building Operations and Maintenance
- Neighbourhood Development

LEED® v4 for Building Design and Construction (BD +C) is used as a reference in this brochure; it includes the following specific rating systems. Points can vary according to each criterion and specific rating systems:

- LEED® v4 BD+C: New Construction
- LEED® v4 BD+C: Core and Shell
- LEED® v4 BD+C: Schools
- LEED® v4 BD+C: Retail
- LEED® v4 BD+C: Data Centres
- LEED® v4 BD+C: Warehouses and Distribution Centres
- LEED® v4 BD+C: Hospitality
- LEED® v4 BD+C: Healthcare

The LEED®v4 rating system Building Design and Construction (BD+C) for New Construction and Major Renovation has eight major categories, five of which can be improved using the plaster and plasterboard solutions from Gyproc in the design of the building.

¹ Source: www.usgbc.org/projects



To find out more about Gyproc and LEED visit gyproc.ie

Solutions you can always trust

SPECIFICATION SALES MANAGERS



National Specification Manager



Barry Hennessy

+353 (0)42 969 8100
barry.hennessy@saint-gobain.com



Northern Region



Mark McCormick

+44 (0)78 554 67301
mark.mccormick@saint-gobain.com



South Dublin, Kildare & Wicklow



George McGreal

+353 (0)86 026 2740
george.mcgreal@saint-gobain.com



Border, West & Midlands



Mark Gunning

+353 (0)86 774 4438
Mark.gunning@saint-gobain.com



Dublin North, Louth & Meath



Lara Gomes Garcia

+353 (0)86 136 3027
Lara.gomes@saint-gobain.com

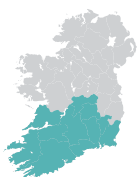

Mid-West, South-East & South-West



Jeff Gallagher

+353 (0)86 774 4437
jeff.gallagher@saint-gobain.com



SAINT-GOBAIN SOLUTIONS

Unit 4, Kilcarbery Business Park,
Nangor Road, Dublin 22
D22 R2Y7
Telephone: 01 629 8400
Email: SGSolutionsIrl@saint-gobain.com



[Saint-GobainIE](#)



[@SaintGobainIreland](#)

Gyproc, Gypframe and Glasroc are all registered trade names of Saint-Gobain Construction Products (Irl) Limited. Isover is a registered trade name of Saint-Gobain. Saint-Gobain Construction Products (Irl) Limited reserves the right to revise product specifications without notice. The information in this document was correct to the best of our knowledge at the time of publication. It is the user's responsibility to ensure that it remains current prior to use. The information in this document is for guidance only and should not be read in isolation. Users should read and familiarise themselves with all the information contained in this document and ensure that they are fully conversant with the products and systems being used, before subsequent specification or installation. For a comprehensive and up-to-date library of information visit the Gyproc website at: www.gyproc.ie